

The fundamentals of millimeter wave radar sensors



Cesar Iovescu
Radar Applications Manager

Sandeep Rao
Radar Systems Architect

Texas Instruments

Introduction

Millimeter wave (mmWave) is a special class of radar technology that uses short-wavelength electromagnetic waves. Radar systems transmit electromagnetic wave signals that objects in their path then reflect. By capturing the reflected signal, a radar system can determine the range, velocity and angle of the objects.

mmWave radars transmit signals with a wavelength that is in the millimeter range. This is considered a short wavelength in the electromagnetic spectrum and is one of the advantages of this technology. Indeed, the size of system components such as the antennas required to process mmWave signals is small. Another advantage of short wavelengths is the high accuracy. An mmWave system operating at 76–81 GHz (with a corresponding wavelength of about 4 mm), will have the ability to detect movements that are as small as a fraction of a millimeter.

A complete mmWave radar system includes transmit (TX) and receive (RX) radio frequency (RF) components; analog components such as clocking; and digital components such as analog-to-digital converters (ADCs), microcontrollers (MCUs) and digital signal processors (DSPs). Traditionally, these systems were implemented with discrete components, which increased power consumption and overall system cost. System design is challenging due the complexity and high frequencies.

Texas Instruments (TI) has solved these challenges and designed complementary metal-oxide semiconductor (CMOS)-based mmWave radar devices that integrate TX-RF and RX-RF analog components such as clocking, and digital components such as the ADC, MCU and hardware accelerator. Some families in TI's mmWave sensor portfolio integrate a DSP for additional signal-processing capabilities.

TI devices implement a special class of mmWave technology called frequency-modulated continuous wave (FMCW). As the name implies, FMCW radars transmit a frequency-modulated signal continuously in order to measure range as well as angle and velocity. This differs from traditional pulsed-radar systems, which transmit short pulses periodically.

Range measurement

The fundamental concept in radar systems is the transmission of an electromagnetic signal that objects reflect in its path. In the signal used in FMCW radars, the frequency increases linearly with time. This type of signal is also called a chirp. **Figure 1** shows a representation of a chirp signal, with magnitude (amplitude) as a function of time.

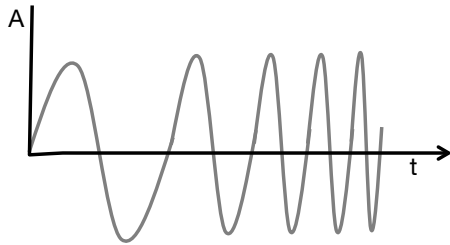

Figure 1. Chirp signal, with amplitude as a function of time.

Figure 2 shows the same chirp signal, with frequency as a function of time. The chirp is characterized by a start frequency (f_c), bandwidth (B) and duration (T_c). The slope of the chirp (S) captures the rate of change of frequency. In the example provided in **Figure 2**, $f_c = 77$ GHz, $B = 4$ GHz, $T_c = 40$ μ s and $S = 100$ MHz/ μ s.

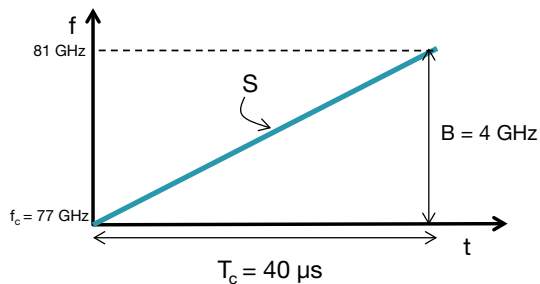

Figure 2. Chirp signal, with frequency as a function of time.

An FMCW radar system transmits a chirp signal and captures the signals reflected by objects in its path.

Figure 3 represents a simplified block diagram of the main RF components of an FMCW radar. The radar operates as follows:

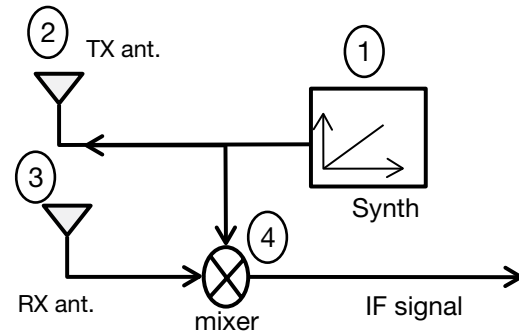

Figure 3. FMCW radar block diagram.

- A synthesizer (synth) generates a chirp.
- The chirp is transmitted by a transmit antenna (TX ant.).
- The reflection of the chirp by an object generates a reflected chirp captured by the receive antenna (RX ant.).
- A “mixer” combines the RX and TX signals to produce an intermediate frequency (IF) signal.

A frequency mixer is an electronic component that combines two signals to create a new signal with a new frequency.

For two sinusoidal inputs x_1 and x_2 (Equations 1 and 2):

$$x_1 = \sin(\omega_1 t + \Phi_1) \quad (1)$$

$$x_2 = \sin(\omega_2 t + \Phi_2) \quad (2)$$

The output x_{out} has an instantaneous frequency equal to the difference of the instantaneous frequencies of the two input sinusoids. The phase of the output x_{out} is equal to the difference of the phases of the two input signals (Equation 3):

$$x_{out} = \sin[(\omega_1 - \omega_2) t + (\Phi_1 - \Phi_2)] \quad (3)$$

The operation of the frequency mixer can also be understood graphically by looking at TX and RX chirp frequency representation as a function of time.

The upper diagram in **Figure 4** on the following page shows TX and RX chirps as a function of time for a single object detected. Notice that the RX chirp is a time-delay version of the TX chirp.

The time delay (τ) can be mathematically derived as Equation 4:

$$\tau = \frac{2d}{c} \quad (4)$$

where d is the distance to the detected object and c is the speed of light.

To obtain the frequency representation as a function of time of the IF signal at the output of the frequency mixer, subtract the two lines presented in the upper section of **Figure 4**. The distance between the two lines is fixed, which means that the IF signal consists of a tone with a constant frequency. **Figure 4** shows that this frequency is $S\tau$. The IF signal is valid only in the time interval where both the TX chirp and the RX chirp overlap (i.e., the interval between the vertical dotted lines in **Figure 4**).

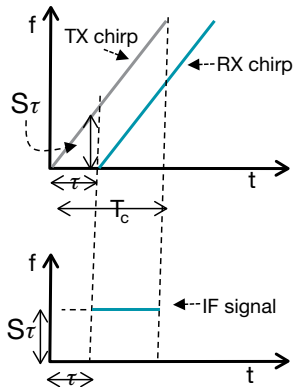

Figure 4. IF frequency is constant.

The mixer output signal as a magnitude function of time is a sine wave, since it has a constant frequency.

The initial phase of the IF signal (Φ_0) is the difference between the phase of the TX chirp and the phase of the RX chirp at the time instant corresponding to the start of the IF signal (i.e., the time instant represented by the left vertical dotted line in **Figure 4**). (Equation 5):

$$\phi_0 = 2\pi f_c \tau \quad (5)$$

Mathematically, it can be further derived into Equation 6:

$$\phi_0 = \frac{4\pi d}{\lambda} \quad (6)^*$$

In summary, for an object at a distance d from the radar, the IF signal will be a sine wave (Equation 7), then:

$$A \sin(2\pi f_0 t + \phi_0) \quad (7)^{**}$$

where $f_0 = \frac{S2d}{c}$ and $\phi_0 = \frac{4\pi d}{\lambda}$.

The assumption so far is that the radar has detected only one object. Let's analyze a case when there are several objects detected. **Figure 5** shows three different RX chirps received from different objects. Each chirp is delayed by a different amount of time proportional to the distance to that object. The different RX chirps translate to multiple IF tones, each with a constant frequency.

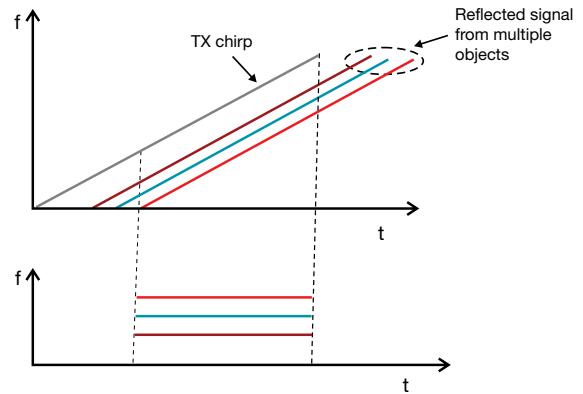

Figure 5. Multiple IF tones for multiple-object detection.

This IF signal consisting of multiple tones must be processed using a Fourier transform in order to separate the different tones. Fourier transform processing will result in a frequency spectrum that has separate peaks for the different tones each

* This equation is an approximation and valid only if Slope and distance are sufficiently small. However, it is still true that the phase of the IF signal responds linearly to a small change in the distance (i.e., $\Delta\phi = 4\pi\Delta d/\lambda$).

** In this introductory white paper we ignore the dependence of the frequency of the IF signal on the velocity of the object. This is usually a small effect in fast-FMCW radars, and further can be easily corrected for once the Doppler-FFT has been processed.

peak denoting the presence of an object at a specific distance.

Range resolution

Range resolution is the ability to distinguish between two or more objects. When two objects move closer, at some point, a radar system will no longer be able to distinguish them as separate objects. Fourier transform theory states that you can increase the resolution by increasing the length of the IF signal.

To increase the length of the IF signal, the bandwidth must also be increased proportionally. An increased-length IF signal results in an IF spectrum with two separate peaks.

Fourier transform theory also states that an observation window (T) can resolve frequency components that are separated by more than $1/THz$. This means that two IF signal tones can be resolved in frequency as long as the frequency difference satisfies the relationship given in Equation 8:

$$\Delta f > \frac{1}{T_c} \quad (8)$$

where T_c is the observation interval.

Since $\Delta f = \frac{S2\Delta d}{c}$, Equation 8 can be expressed as $\Delta d > \frac{c}{2ST_c} = \frac{c}{2B}$ (since $B = ST_c$).

The range resolution (d_{Res}) depends only on the bandwidth swept by the chirp (Equation 9):

$$d_{Res} = \frac{c}{2B} \quad (9)$$

Thus an FMCW radar with a chirp bandwidth of a few GHz will have a range resolution in the order of centimeters (e.g., a chirp bandwidth of 4 GHz translates to a range resolution 3.75 cm).

Velocity measurement

In this section, let's use phasor notation (distance, angle) for a complex number.

Velocity measurement with two chirps

In order to measure velocity, an FMCW radar transmits two chirps separated by T_c . Each reflected chirp is processed through FFT to detect the range of the object (range-FFT). The range-FFT corresponding to each chirp will have peaks in the same location, but with a different phase. The measured phase difference corresponds to a motion in the object of vT_c .

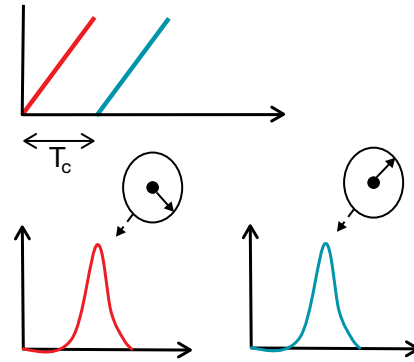

Figure 6. Two-chirp velocity measurement.

The phase difference is derived from Equation 6 as Equation 10:

$$\Delta\Phi = \frac{4\pi v T_c}{\lambda} \quad (10)$$

You can derive the velocity using Equation 11:

$$v = \frac{\lambda \Delta\Phi}{4\pi T_c} \quad (11)$$

Since the velocity measurement is based on a phase difference, there will be ambiguity. The measurement is unambiguous only if $|\Delta\Phi| < \pi$. Using Equation 11 above, one can mathematically derive $v < \frac{\lambda}{4T_c}$.

Equation 12 provides the maximum relative speed (v_{max}) measured by two chirps spaced T_c apart. Higher v_{max} requires shorter transmission times between chirps.

$$v_{max} = \frac{\lambda}{4T_c} \quad (12)$$

Velocity measurement with multiple objects at the same range

The two-chirp velocity measurement method does not work if multiple moving objects with different velocities are at the time of measurement, both at the same distance from the radar. Since these objects are at the same distance, they will generate reflective chirps with identical IF frequencies. As a consequence, the range-FFT will result in single peak, which represents the combined signal from all of these equi-range objects. A simple phase comparison technique will not work.

In this case, in order to measure the speed, the radar system must transmit more than two chirps. It transmits a set of N equally spaced chirps. This set of chirps is called a chirp frame. **Figure 7** shows the frequency as a function of time for a chirp frame.

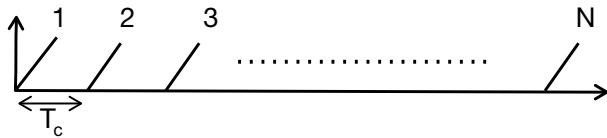

Figure 7. Chirp frame.

The processing technique is described below using the example of two objects equidistant from the radar but with different velocities v_1 and v_2 .

Range-FFT processes the reflected set of chirps, resulting in a set of N identically located peaks, but each with a different phase incorporating the phase contributions from both these objects (the individual phase contributions from each of these objects being represented by the red and blue phasors in **Figure 8**).

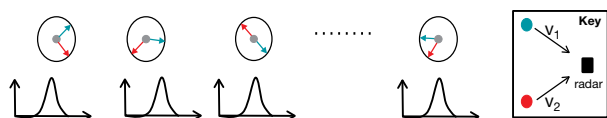

Figure 8. The range-FFT of the reflected chirp frame results in N phasors.

A second FFT, called Doppler-FFT, is performed on the N phasors to resolve the two objects, as shown in **Figure 9**.

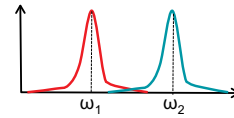

Figure 9. Doppler-FFT separates the two objects.

ω_1 and ω_2 correspond to the phase difference between consecutive chirps for the respective objects (Equation 13):

$$v_1 = \frac{\lambda \omega_1}{4\pi T_c}, \quad v_2 = \frac{\lambda \omega_2}{4\pi T_c} \quad (13)$$

Velocity resolution

The theory of discrete Fourier transforms teaches us that two discrete frequencies, ω_1 and ω_2 , can be resolved if $\Delta\omega = \omega_2 - \omega_1 > 2\pi/N$ radians/sample.

Since $\Delta\omega$ is also defined by the following equation $\Delta\Phi = \frac{4\pi v T_c}{\lambda}$ (Equation 10), one can mathematically derive the velocity resolution (v_{res}) if the frame period $T_f = N T_c$ (Equation 14):

$$v > v_{res} = \frac{\lambda}{2T_f} \quad (14)$$

The velocity resolution of the radar is inversely proportional to the frame time (T_f).

Angle detection

Angle estimation

An FMCW radar system can estimate the angle of a reflected signal with the horizontal plane, as shown in **Figure 10**. This angle is also called the angle of arrival (AoA).

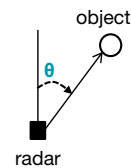

Figure 10. Angle of arrival.

Angular estimation is based on the observation that a small change in the distance of an object results in a phase change in the peak of the range-FFT or Doppler-FFT. This result is used to perform angular estimation, using at least two RX antennas as shown in **Figure 11**. The differential distance from the object to each of the antennas results in a phase change in the FFT peak. The phase change enables you to estimate the AoA.

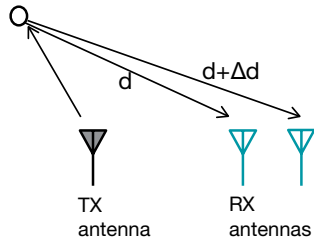

Figure 11. Two antennas are required to estimate AoA.

In this configuration, the phase change is derived mathematically as Equation 15:

$$\Delta\Phi = \frac{2\pi\Delta d}{\lambda} \quad (15)$$

Under the assumption of a planar wavefront basic geometry shows that $\Delta d = l \sin(\theta)$, where l is the distance between the antennas. Thus the angle of arrival (θ), can be computed from the measured $\Delta\Phi$ with Equation 16:

$$\theta = \sin^{-1}\left(\frac{\lambda\Delta\Phi}{2\pi l}\right) \quad (16)$$

Note that $\Delta\Phi$ depends on $\sin(\theta)$. This is called a nonlinear dependency. $\sin(\theta)$ is approximated with a linear function only when θ has a small value: $\sin(\theta) \sim \theta$.

As a result, the estimation accuracy depends on AoA and is more accurate when θ has a small value. as shown in **Figure 12**.

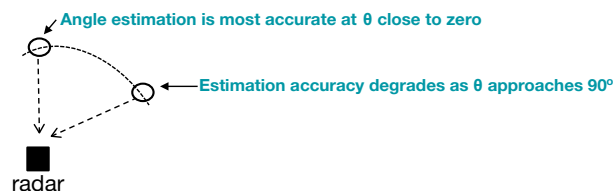

Figure 12. AoA estimation is more accurate for small values.

Maximum angular field of view

The maximum angular field of view of the radar is defined by the maximum AoA that the radar can estimate. See **Figure 13**.

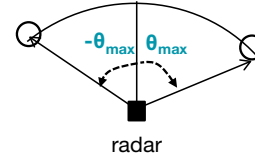

Figure 13. Maximum angular field of view.

Unambiguous measurement of angle requires $|\Delta\omega| < 180^\circ$. Using Equation 16, this corresponds to $\frac{2\pi l \sin(\theta)}{\lambda} < \pi$.

Equation 17 shows that the maximum field of view that two antennas spaced l apart can service is:

$$\theta_{max} = \sin^{-1}\left(\frac{\lambda}{2l}\right) \quad (17)$$

A spacing between the two antennas of $l = \lambda/2$ results in the largest angular field of view $\pm 90^\circ$.

Texas Instruments mmWave sensor solution

As you can see, an FMCW sensor is able to determine the range, velocity and angle of nearby objects by using a combination of RF, analog and digital electronic components.

Figure 14 is a block diagram of the different components.

TI has brought innovation to the field of FMCW sensing by integrating a DSP, MCU and the TX RF, RX RF, analog and digital components into a RFCMOS single chip.

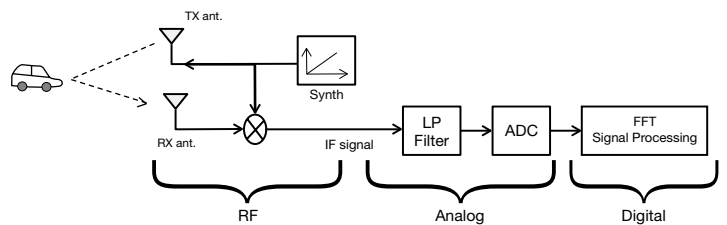

Figure 14. RF, analog and digital components of an FMCW sensor.

TI's RFCMOS mmWave sensors differentiate themselves from traditional SiGe-based solutions by enabling flexibility and programmability in the mmWave RF front-end and the MCU/HWA/DSP processing back-end. Whereas a SiGe-based solution can only store a limited number of chirps and requires real-time intervention to update chirps and chirp profiles during an actual frame, TI's mmWave sensor solutions are able to store 512 chirps with four profiles before a frame starts. This capability allows TI's mmWave sensors to be easily configured with multiple configurations to maximize the amount of useful data extracted from a scene. Individual chirps and the processing back-end can be tailored "on-the-fly" for real-time application needs such as higher range, higher velocities, higher resolution, or specific processing algorithms.

The TI mmWave Sensor portfolio for "**Automotive**" scales from high-performance radar front-end to highly-integrated single-chip edge sensors. Designers can address advanced driver assistance systems (ADAS) and autonomous driving safety regulations— including ISO 26262, which enables Automotive Safety Integrity Level (ASIL)-B— with the AWR mmWave portfolio.

The TI mmWave sensor portfolio for "**Industrial**" includes both 76-81GHz and 60-64GHz with highly integrated single chip edge sensors .

The on-chip DSP provides more flexibility and allows for software integration of high-level algorithms, such as object tracking and classification. These single-chip devices provide simple access to the high-accuracy object data including range, velocity and angle that enables advanced sensing in rising applications that demand performance and efficiency such as smart infrastructure, Industry 4.0 in factory and building automation products and autonomous drones.

Texas Instruments has introduced a complete development environment for engineers working on industrial and automotive mmWave sensor products which include:

- **Hardware Evaluation Modules** for the [Automotive](#) and [Industrial](#) mmWave sensors
- **mmWave software development kit (SDK)** which includes RTOS, drivers, signal-processing libraries, mmWave API, mmWaveLink and security (available separately).
- **mmWave Studio** off-line tools for algorithm development and analysis which includes data capture, visualizer and system estimator.

To learn more about mmWave products, tools and software please visit www.ti.com/mmwave and start your design today.

Important Notice: The products and services of Texas Instruments Incorporated and its subsidiaries described herein are sold subject to TI's standard terms and conditions of sale. Customers are advised to obtain the most current and complete information about TI products and services before placing orders. TI assumes no liability for applications assistance, customer's applications or product designs, software performance, or infringement of patents. The publication of information regarding any other company's products or services does not constitute TI's approval, warranty or endorsement thereof.

The platform bar is a trademark of Texas Instruments. All other trademarks are the property of their respective owners.

IMPORTANT NOTICE AND DISCLAIMER

TI PROVIDES TECHNICAL AND RELIABILITY DATA (INCLUDING DATASHEETS), DESIGN RESOURCES (INCLUDING REFERENCE DESIGNS), APPLICATION OR OTHER DESIGN ADVICE, WEB TOOLS, SAFETY INFORMATION, AND OTHER RESOURCES "AS IS" AND WITH ALL FAULTS, AND DISCLAIMS ALL WARRANTIES, EXPRESS AND IMPLIED, INCLUDING WITHOUT LIMITATION ANY IMPLIED WARRANTIES OF MERCHANTABILITY, FITNESS FOR A PARTICULAR PURPOSE OR NON-INFRINGEMENT OF THIRD PARTY INTELLECTUAL PROPERTY RIGHTS.

These resources are intended for skilled developers designing with TI products. You are solely responsible for (1) selecting the appropriate TI products for your application, (2) designing, validating and testing your application, and (3) ensuring your application meets applicable standards, and any other safety, security, or other requirements. These resources are subject to change without notice. TI grants you permission to use these resources only for development of an application that uses the TI products described in the resource. Other reproduction and display of these resources is prohibited. No license is granted to any other TI intellectual property right or to any third party intellectual property right. TI disclaims responsibility for, and you will fully indemnify TI and its representatives against, any claims, damages, costs, losses, and liabilities arising out of your use of these resources.

TI's products are provided subject to TI's Terms of Sale (<https://www.ti.com/legal/termsofsale.html>) or other applicable terms available either on [ti.com](https://www.ti.com) or provided in conjunction with such TI products. TI's provision of these resources does not expand or otherwise alter TI's applicable warranties or warranty disclaimers for TI products.

Mailing Address: Texas Instruments, Post Office Box 655303, Dallas, Texas 75265
Copyright © 2021, Texas Instruments Incorporated